

HEAT SHIELD

Turbine Kinetics Part Number KT50J971-01
Pratt & Whitney Part Number 50J971-01

Engine Eligibility:
[See FAA/PMA Supplement](#)

IPC Reference:
PW4000-72-41

Quantity Per Engine:
4

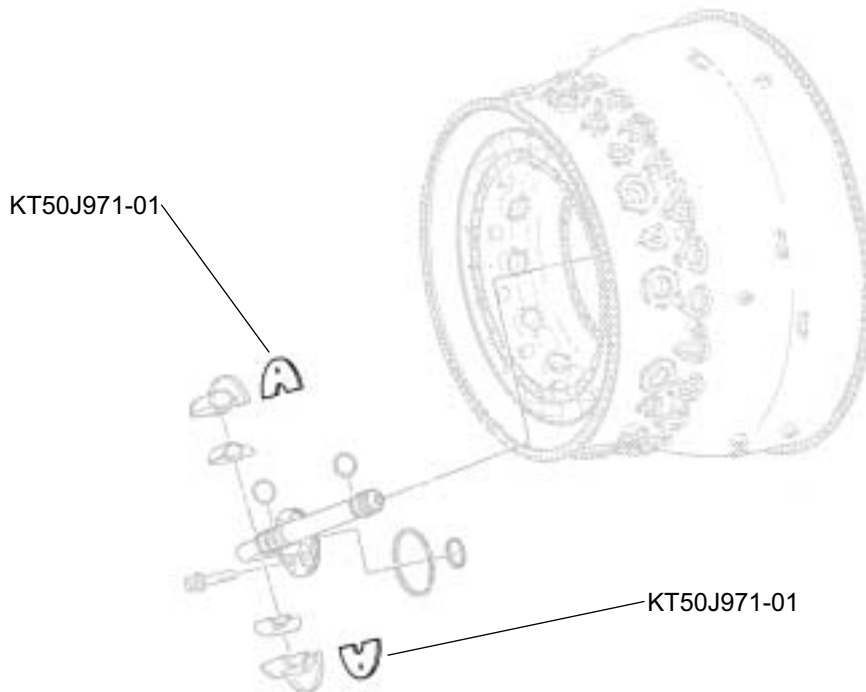

Engine Location:
Diffuser and Combustion Group

