

HEICO

COVER STRIP-HEAT SHIELD GAP

Turbine Kinetics Part Number: 313W3829Y1KT

Boeing Part Number: 313W3829Y1

Next Higher Assembly Part Number: 313W3820-1, -5001, -5002, -5003
- Heat Shield Installation-Lower / Heat Shield Instl

Eligibility:

[See FAA PMA Supplement](#)

[Approval For an Alternative Method of Compliance \(AMOC\)](#)

IPC Reference:

B777-54-54

Quantity:

As required

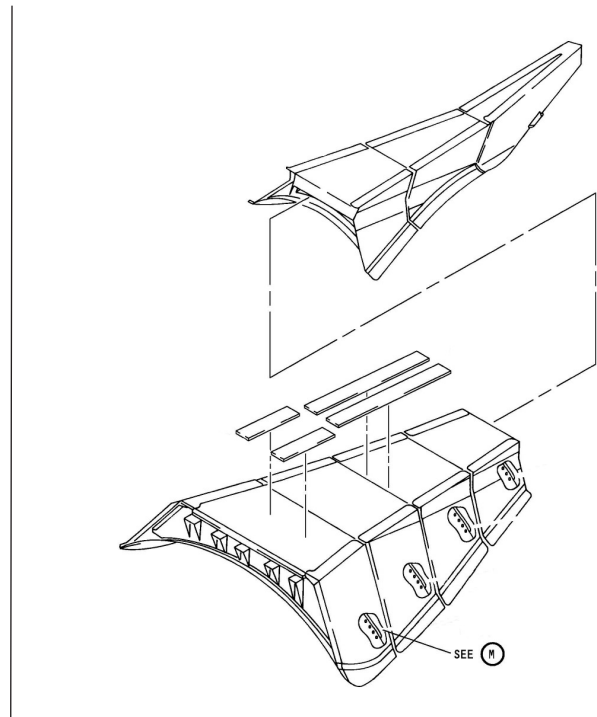
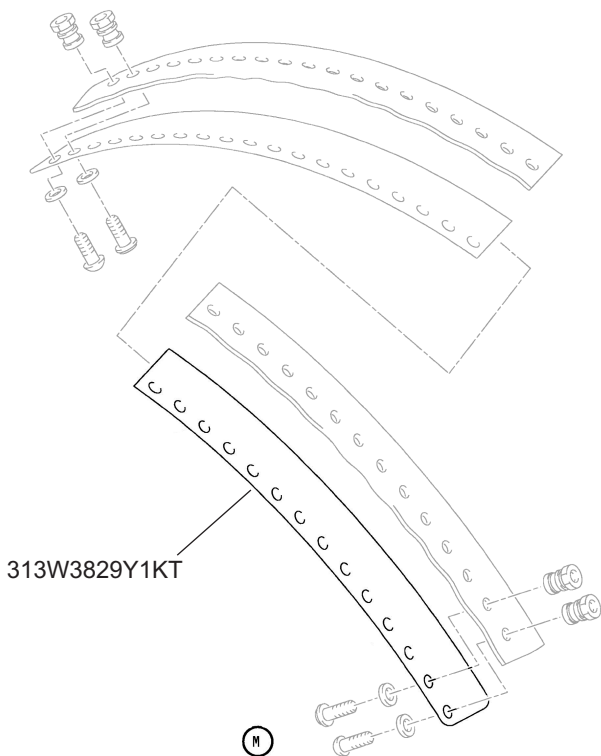

Location:

Lower Heatshield Installation