

SEAL

Turbine Kinetics Part Number 1881M34P001AQQ
CFM International Part Number 1881M34P001A

Engine Eligibility:
[See FAA/PMA Supplement](#)



IPC Reference:
CFM56-72-51

Quantity Per Engine:
As Required

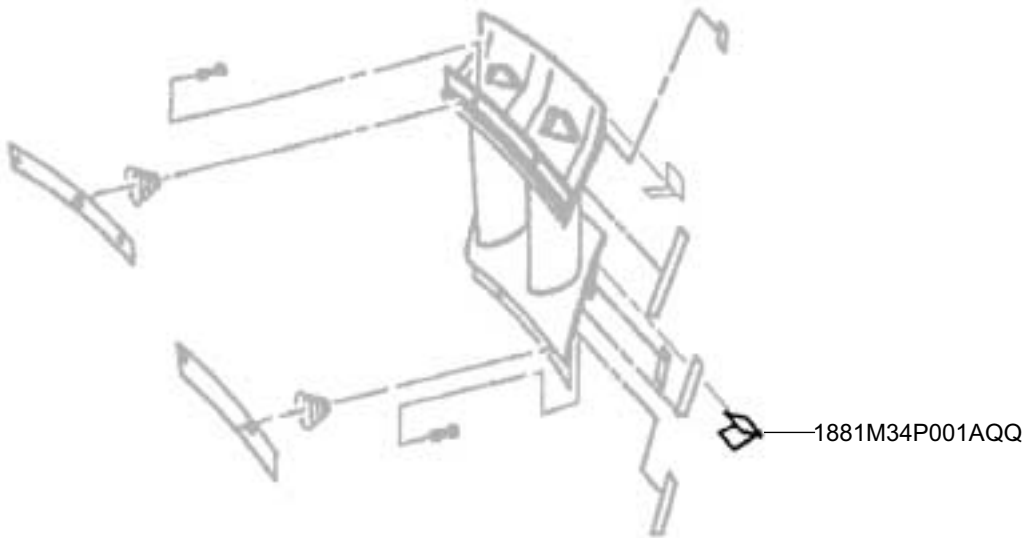

Engine Location:
HPT Nozzle Assembly

