

## SEAL

Turbine Kinetics Part Number 1523M85P01QQ  
CFM International Part Number 1523M85P01

**Engine Eligibility:**  
[See FAA/PMA Supplement](#)

**IPC Reference:**  
CFM56-72-51

**Quantity Per Engine:**  
As Required

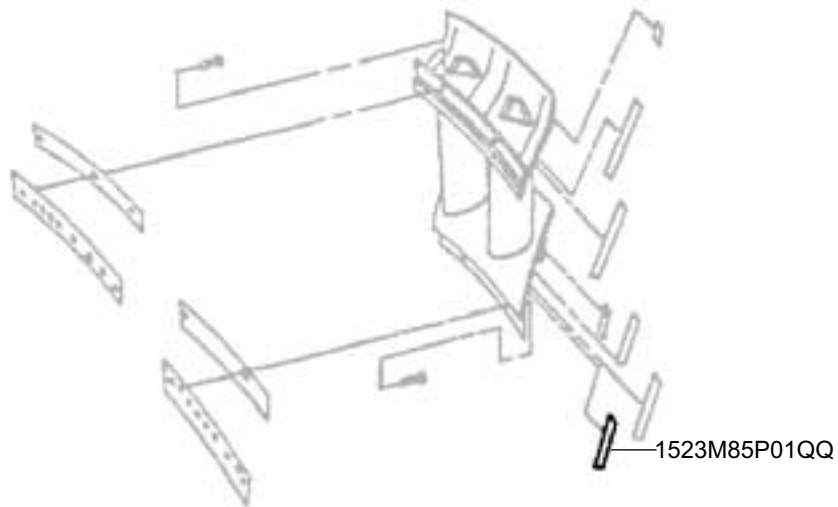
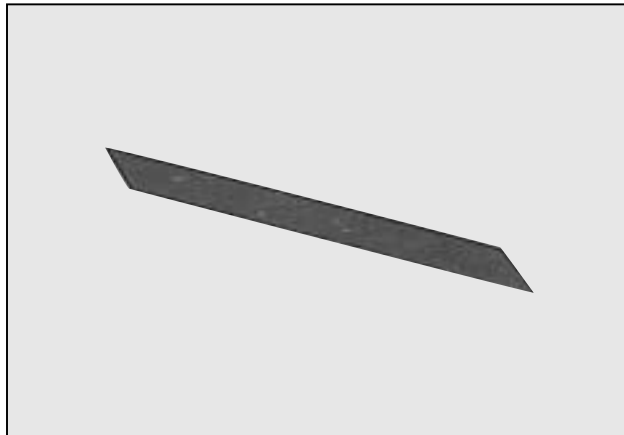

**Engine Location:**  
HPT Nozzle Assembly

