

THERMAL INSULATION BLANKET

Thermal Structures Part Number 11-810102-2
CFM International Part Number 305-389-701-0

Engine Eligibility:
[See FAA/PMA Supplement](#)

IPC Reference:
CFM56-72-54

Quantity Per Engine:
1

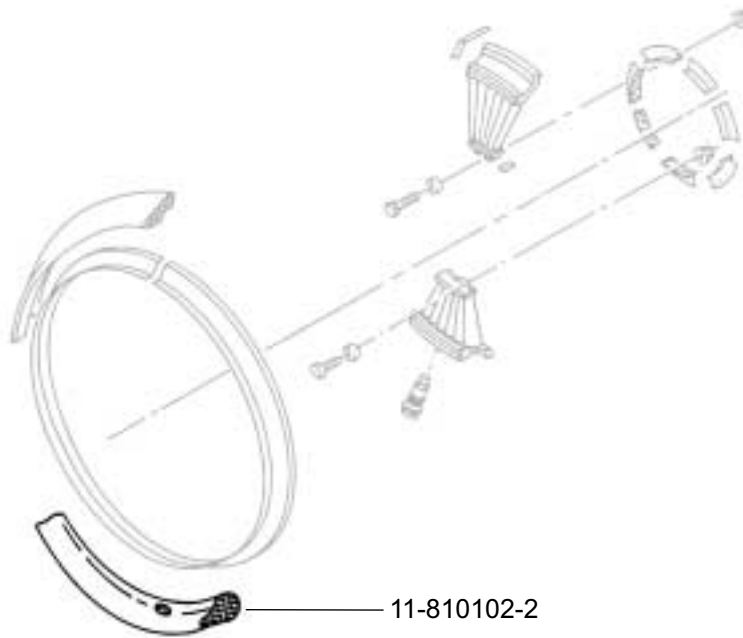

Engine Location:
LPT Rotor / Stator Assembly

