

## THERMAL INSULATION BLANKET

Thermal Structures Part Number 11-810102-1  
CFM International Part Number 305-389-601-0

**Engine Eligibility:**  
[See FAA/PMA Supplement](#)

**IPC Reference:**  
CFM56-72-54

**Quantity Per Engine:**  
3

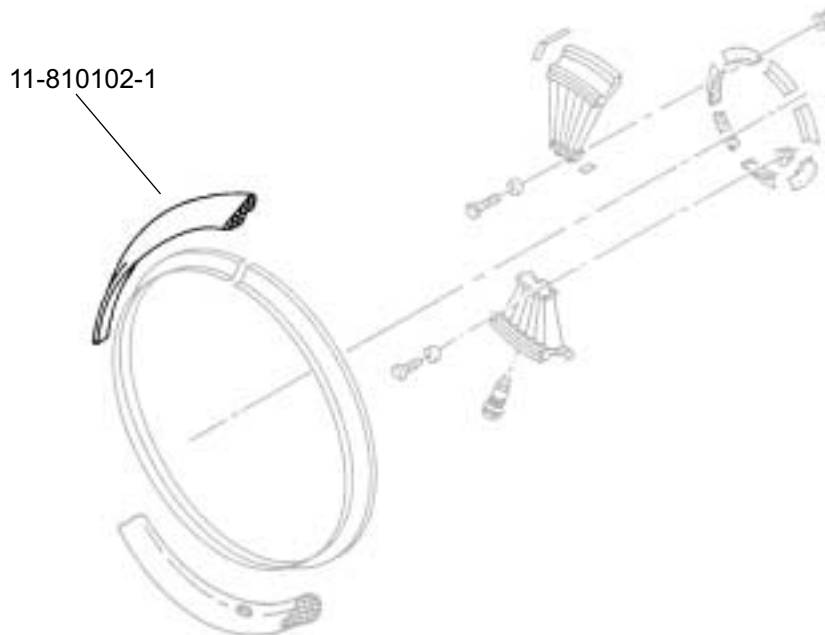

**Engine Location:**  
LPT Rotor / Stator Assembly

